

moteur rapide de 0,35 cm³

monocylindre à tiroir cylindrique

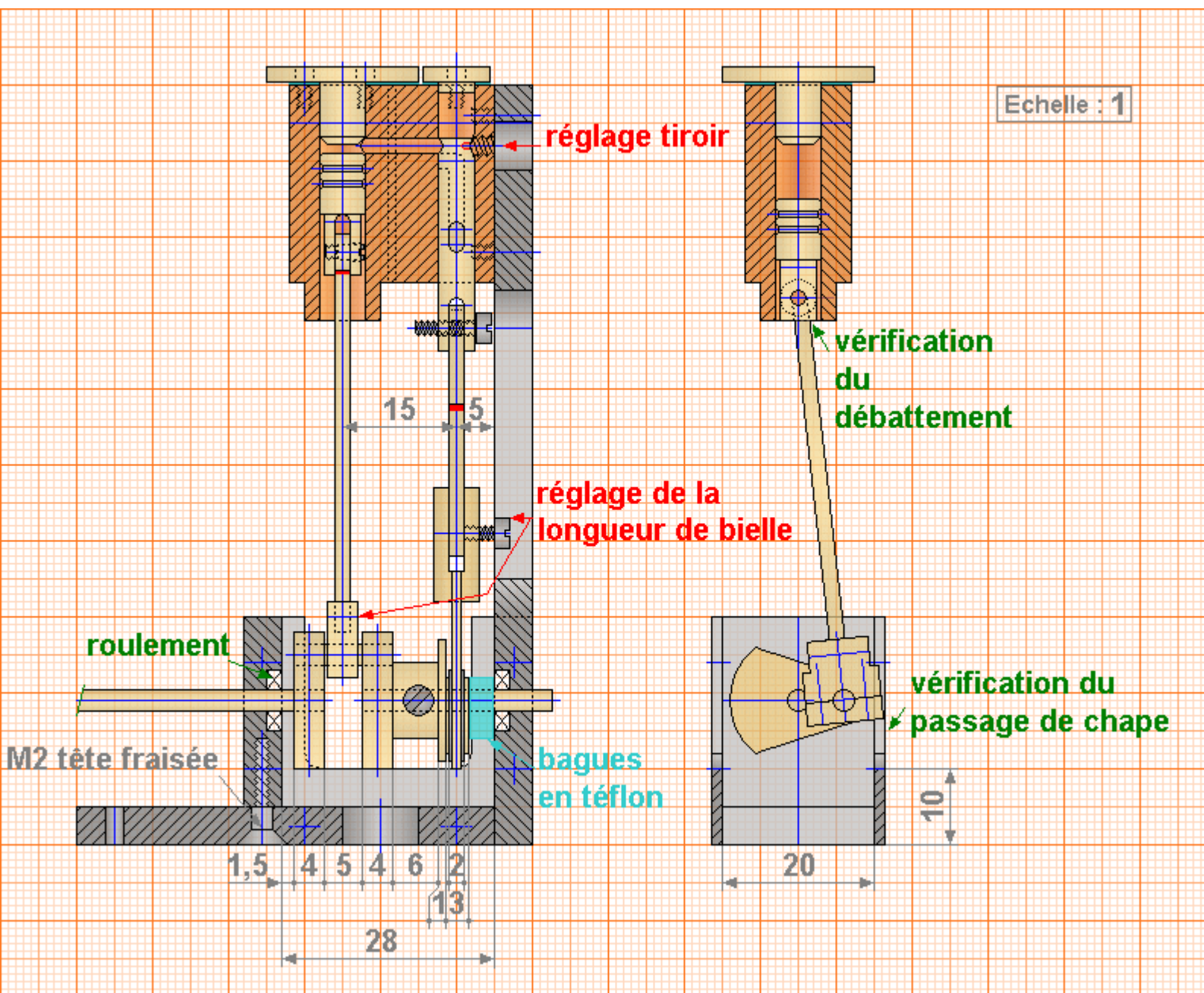

vue d'ensemble

conception et construction : Jacques CLABAUX
dessins : Eric GAUTHIER

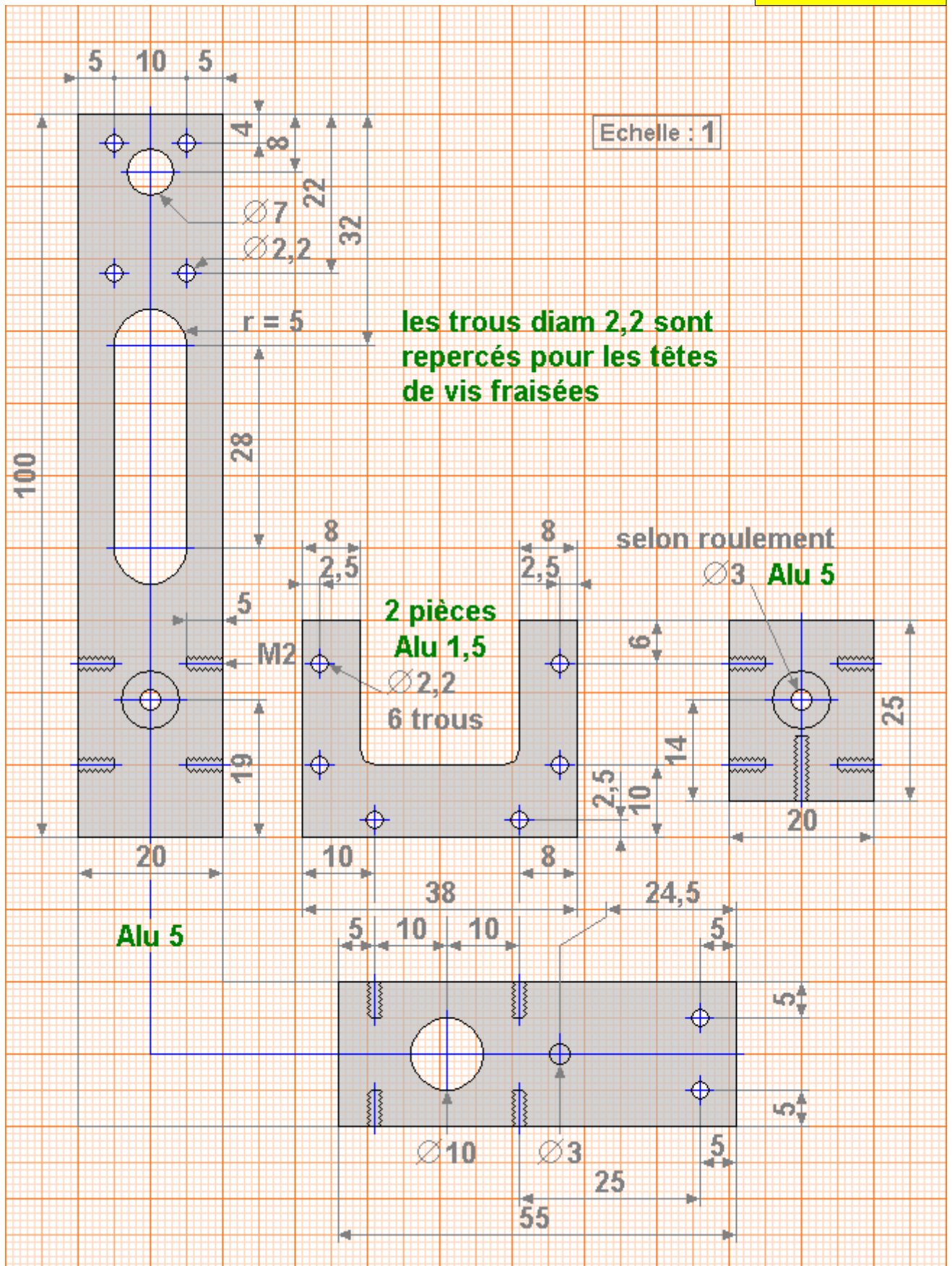

cylindre

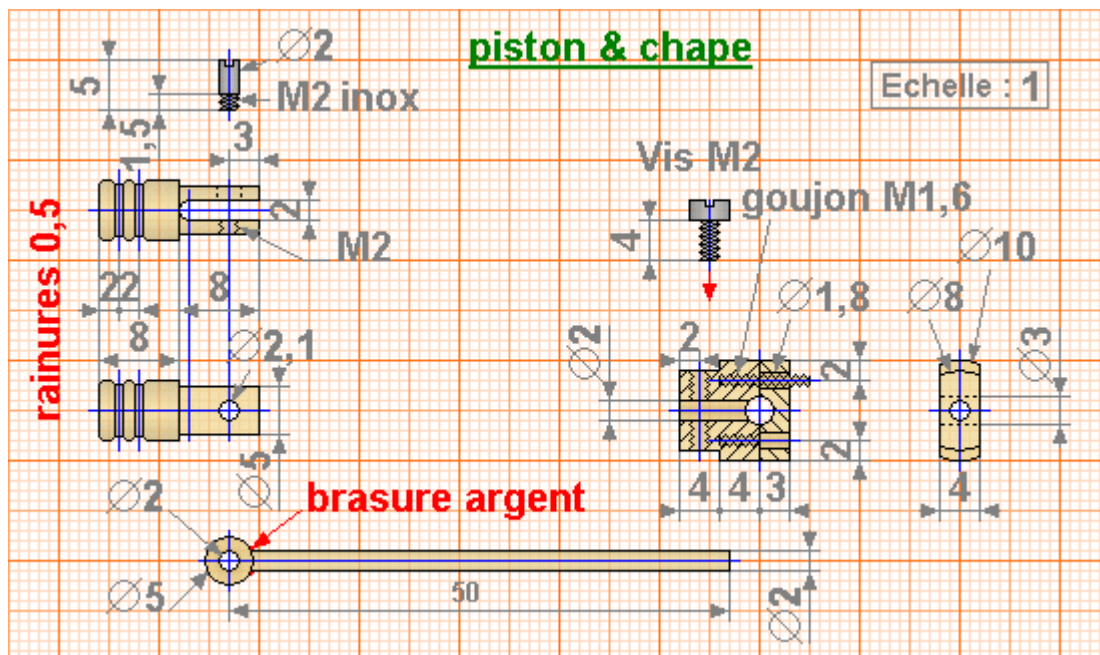
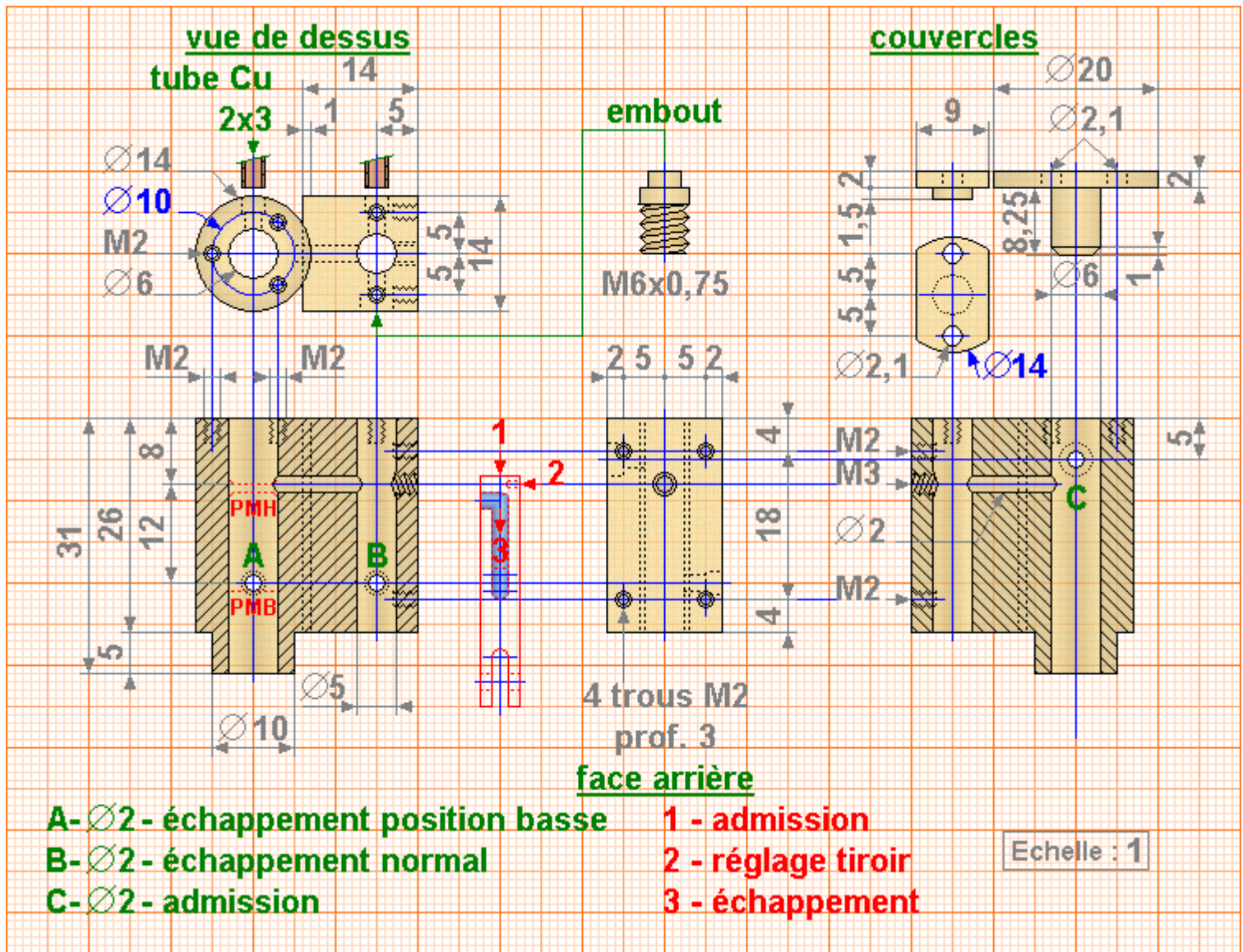

piston

tiroir

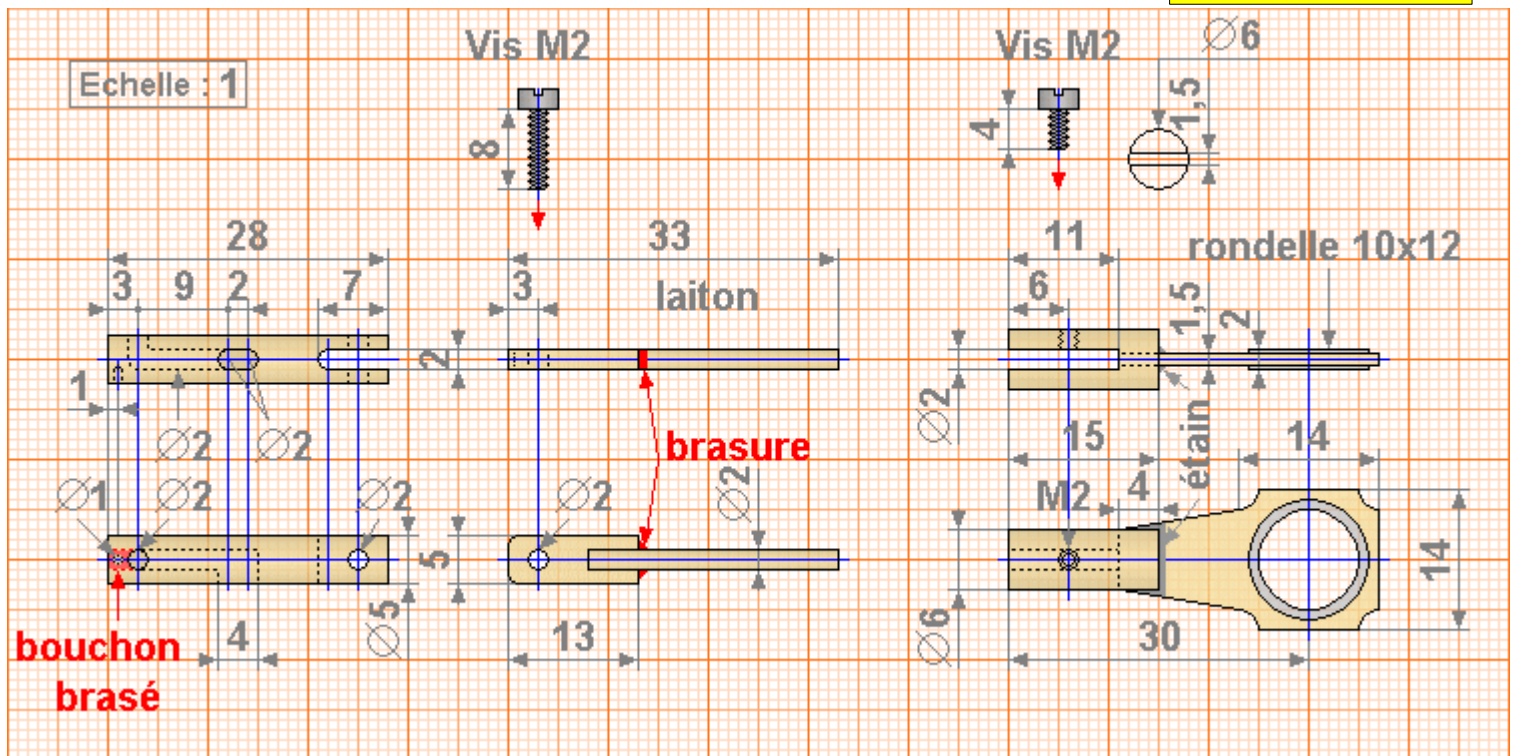

vilebrequin

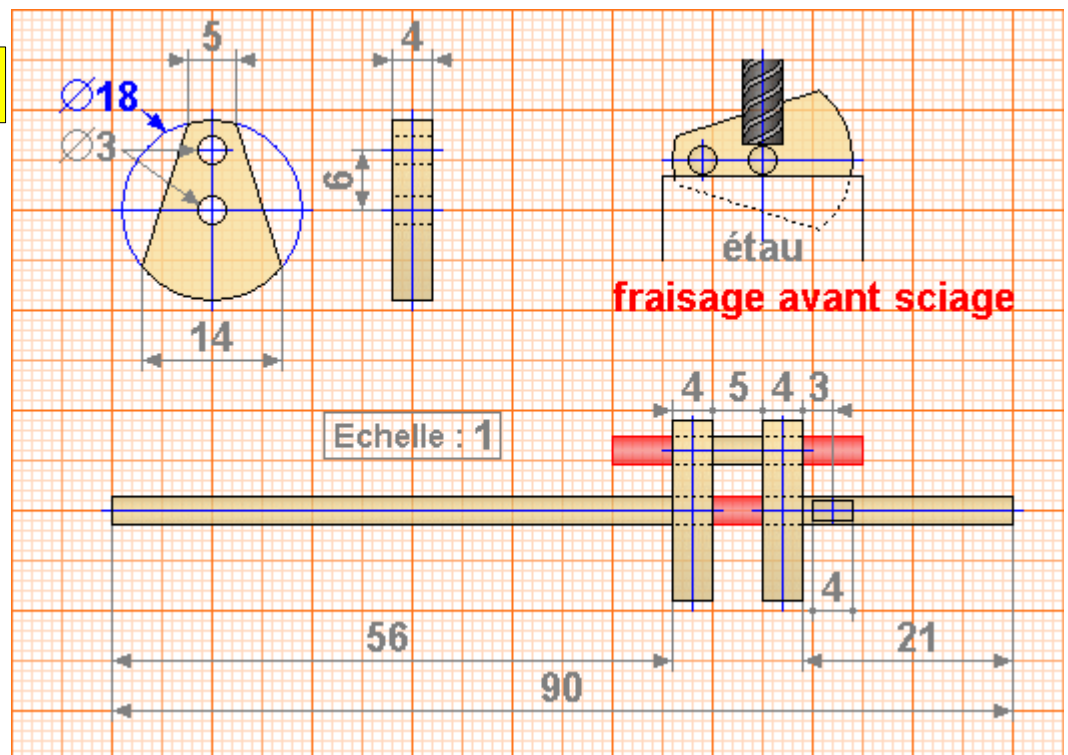

excentrique

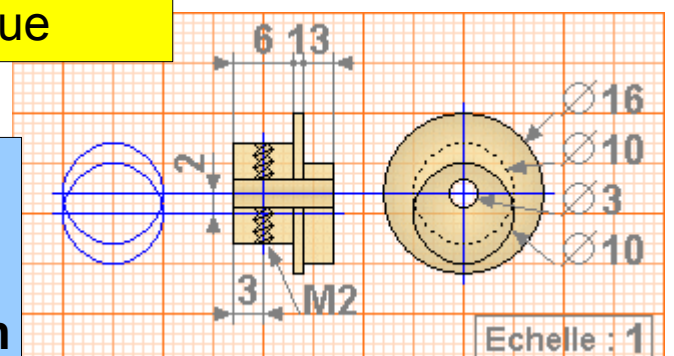

construction et compléments
 sur
 www.vapeuretmodesavapeur.com